

HF-3600E-IOLINK/MODTCP/RS232 RFID Reader



Model Number	Part Number	Description
HF-3600E-IOLINK	830-8060-00M124P	Model HF-3600E-IOLINK 13.56 MHz HF RFID Reader w/on Board Processor & internal Antenna, 4pin M12 connector, both ISO 15693 & ISO 14443
HF-3600E-MODTCP	830-8080-00M128P	Model HF-3600E-MODTCP 13.56 MHz HF RFID Reader w/on Board Modbus TCP Processor & internal Antenna, 8pin M12 connector, both ISO 15693 & ISO 14443
Model HF3600E-RS232	830-8030-00M128P	Model HF-3600E-RS232 13.56 MHz HF RFID Reader w/on Board Serial Processor & internal Antenna, 8pin M12 connector, capable of both ISO 15693 & ISO 14443

Mechanical:	Measurements:	80 x 40 x 84.5mm	3.15" x 1.57" x 3.33"
	Material:	PBT	
	Weight:	4.3 ounces	122 grams
	LED's:	Solid Green = Power On	Tag Present = Yellow On
Certs/Compliance:	RoHS III	REACH	CE
	FCC Part 15 & ETSI	SIL2	Free of BBP, DEHP, DBP, DIBP
	EN 60068-2-27 Shock	EN 60068-2-32 Drop	EN 60068-2-6 Vibration

RF:	Standard:	ISO 15693 & 14443	Reader & Tag Writer
	Frequency:	13.56 MHz	HF (high frequency)
Operation:	Power/Connector:	9 to 28vdc @ 150mA typical	M12 Male 4-pin
	Baud & Communications:	Up to 115.2k baud	IOLINK w/Tag Present Option

Environmental:	Storage & Operate Temp:	-40°F to +185°F	-40°C to +85°C
	Life/IP:	40 Year Shelf Life	IP67

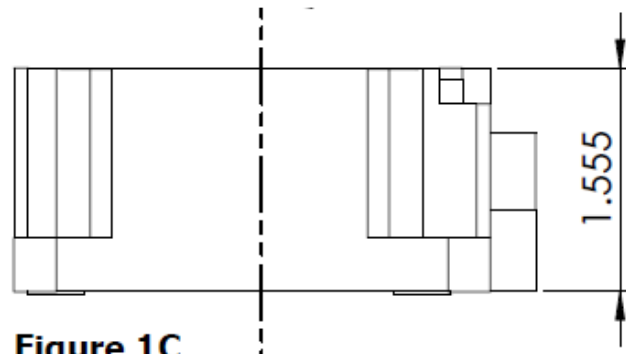
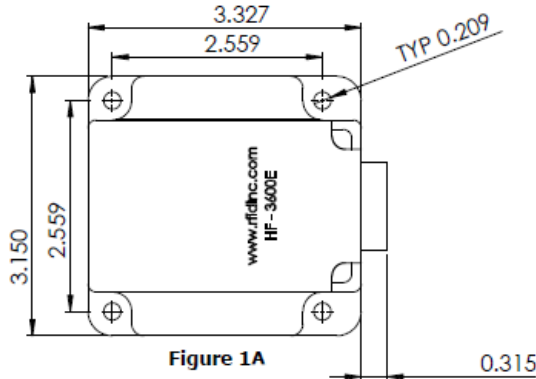

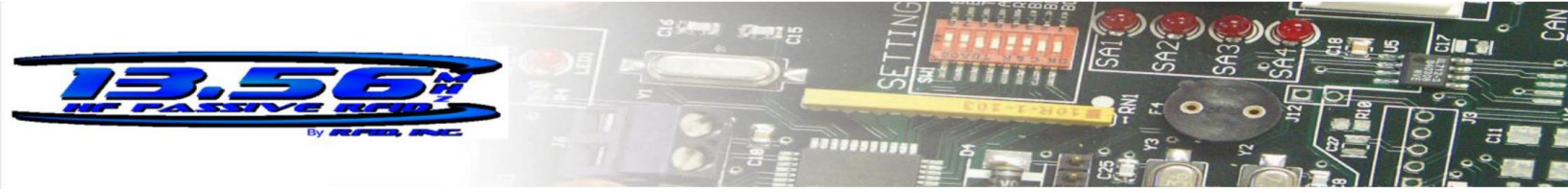

HF-3021E-USB/RS232 RFID Reader

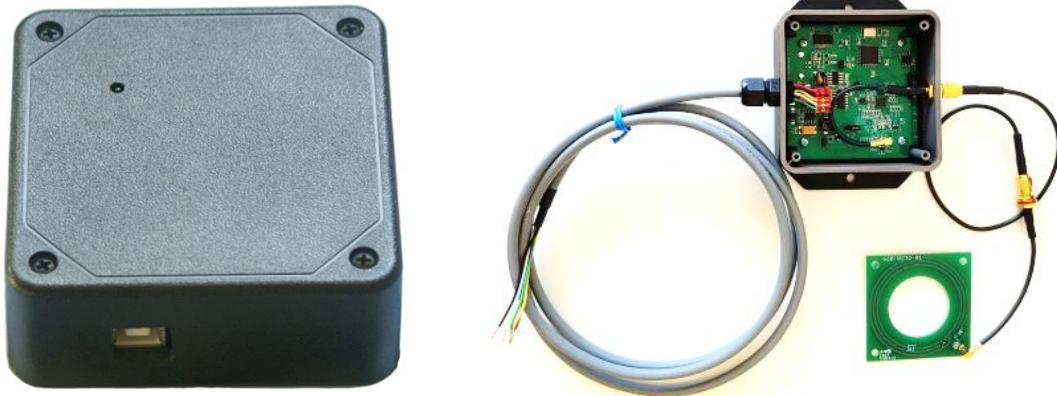

Model Number	Part Number	Description	Read Range
Model HF-3021E-USB-IA	830-0006-00-USB-IA	Model HF-3021E-USB-IA HF 13.56 MHz ISO 15693 & ISO 14443 RFID Reader ABS housing w/internal Antenna	20mm diameter Tag – 3” 50mm diameter Tag – 4.75”
Model HF-3021E-RS232	830-0006-00	Model HF-3021E-RS232 HF 13.56 MHz ISO 15693 & 14443 RFID Reader/Writer, pigtail both serial & power	Please see next page for additional read ranges.

Mechanical:	Measurements:	84mm x 101mm x 34mm	3.325” x 4” x 1.34”
	Material:	ABS Housing	
	Weight:	4.4 ounces	0.275 lbs
	LED:	Solid = Power On	Tag Present = LED Blink
Certs/Compliance:	RoHS III	REACH	CE
	FCC Part 15 & ETSI	SIL2	Free of BBP, DEHP, DBP, DIBP

RF:	Standard:	ISO 15693 & 14443	RFID Reader & Tag Writer
	Frequency:	13.56 MHz	HF (high frequency)
	Power:	8-28vdc	
		150mA Typical	125mA min - 200mA max
	Software:	Windows Based Free Download	
	Security:	Password Protection Option	Kill Tag Option

Environmental:	Operating Temp:	-40°F to +185°F	-40°C to +85°C
	Life/IP:	40 Year Shelf Life	IP65

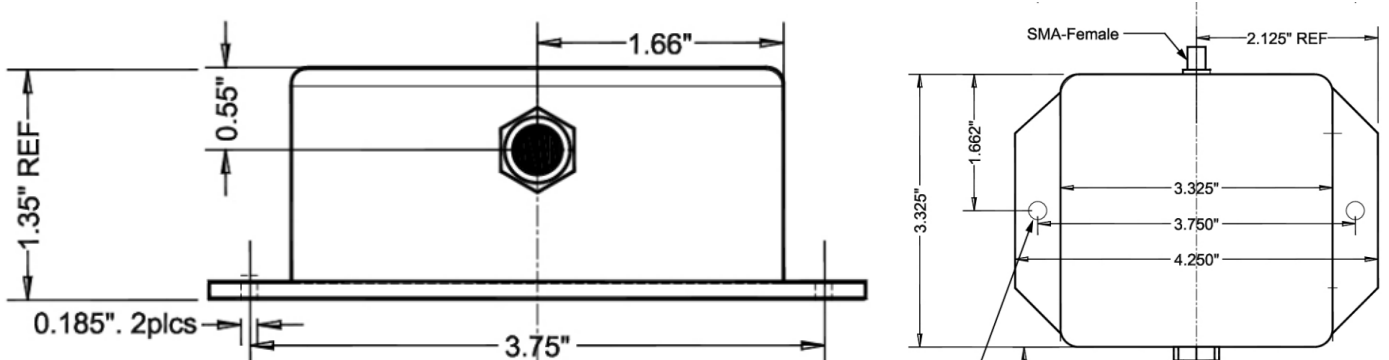

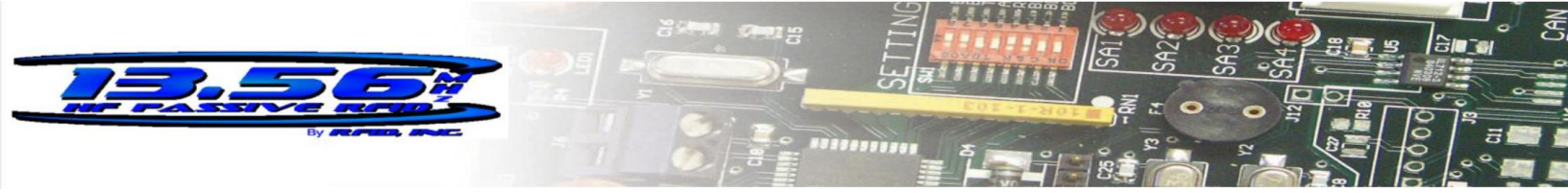

RFID HF Antennas Model HF-1580 Series

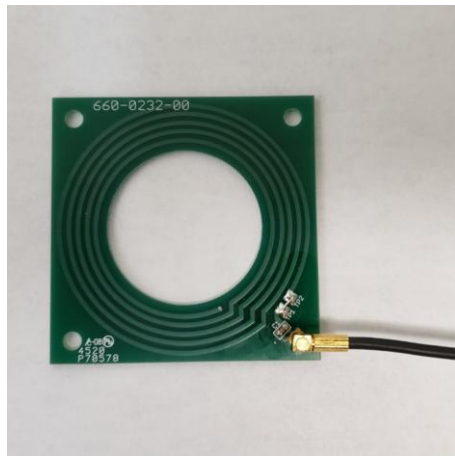

Environment:	Dimensions	60x60mm, 50x50mm, 60x24mm	2.4"x2.4", 2"x2", 2.37x.95"
	Material:	Polycarbonate	2 Part Potting Compound
	Storage Temperature:	-40°F to +185°F	-40°C to +85°C
	Operating Temperature:	-40°F to +185°F	-40°C to +85°C
	Ingress Protection:	IP-68	

Part Numbering	Description	Model Number	Part Number	Read Range
	60x60mm FR4	HF-5102-6060	830-0719-02	20mm diameter Tag – .5" 50mm diameter Tag - 1.75"
	50x50mm FR4	HF-5102-5050	830-0719-03	20mm diameter Tag – 1" 50mm diameter Tag – 1.5"
	M18 Threaded Prox Style	HF-5102-18	830-0719-04	20mm diameter Tag – 50mm diameter Tag –

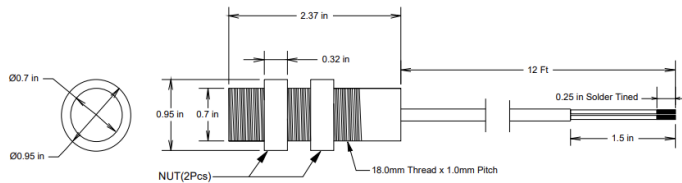
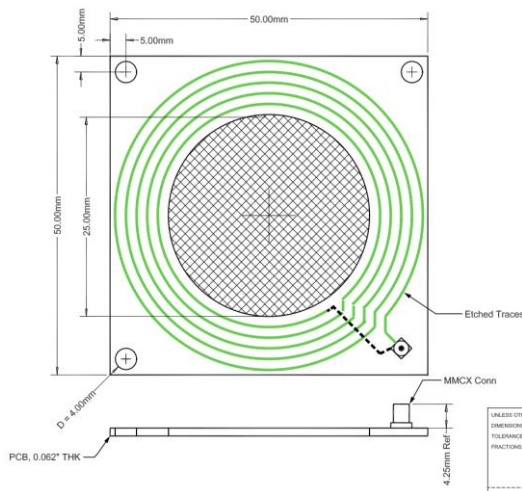

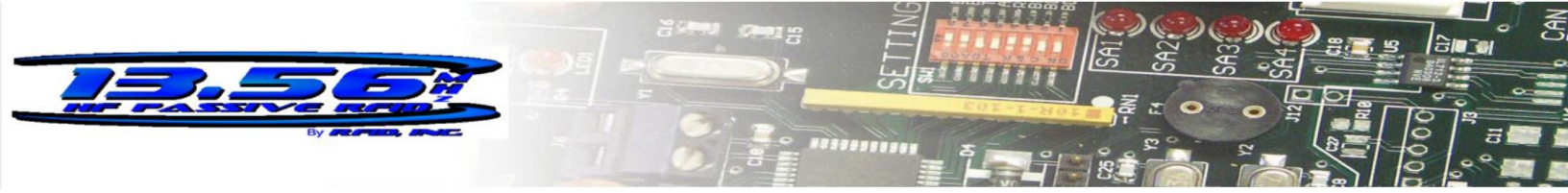

HF High Temperature Tags

Model HF-1572 Series

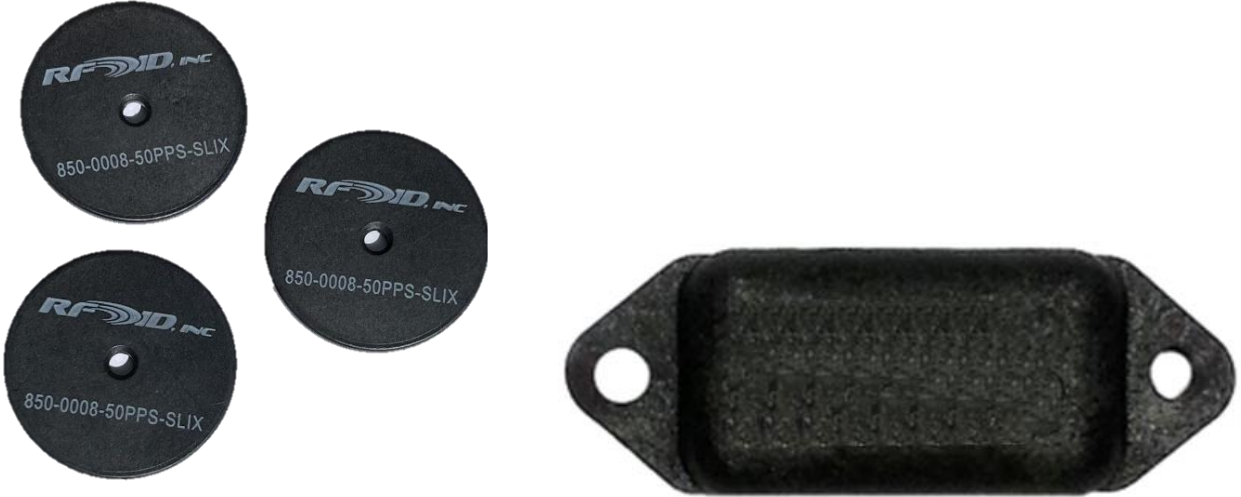

Part Numbering	Description	Model Number	Part Number
	300C RFID Tag 76x28mm	HF-1572-BT3HTM-SLIXS	850-0074BT3HTM-SLIXS
	220C Data Carrier 20mm dia.	HF-1572-20-PPS-SLIX	850-0008-20PPS-SLIX
	220C Data Carrier, 25mm dia.	HF-1572-25-PPS-SLIX	850-0008-25PPS-SLIX
	220C Data Carrier, 30mm dia.	HF-1572-30-PPS-SLIX	850-0008-30PPS-SLIX
	220C Data Carrier, 50mm dia.	HF-1572-50-PPS-SLIX	850-0008-50PPS-SLIX
	Fiberglass Data Carrier 30mm dia.	HF-1572-30-FBR-SLIX	850-0008-30FBR-SLIX
	Fiberglass Data Carrier 50mm dia.	HF-1572-50-FBR-SLIX	850-0008-50FBR-SLIX
	220C Data Carrier, 20mm dia.	HF-1572-20-PPS-2kFRAM	850-0009-20PPS2kFRAM
	220C Data Carrier, 30mm dia.	HF-1572-30-PPS-2kFRAM	850-0009-30PPS2kFRAM
	220C Data Carrier, 50mm dia.	HF-1572-50-PPS-2kFRAM	850-0009-50PPS2kFRAM
	230C RFID Tag, 22mm dia., CS	HF-1572-22-CS-HT	850-0074-22CS-HT
	230C RFID Tag, 22mm dia., ULC	HF-1572-22-HT-ULC	850-0074-22HT-ULC
	230C RFID Tag, 22mm dia., SLI	HF-1572-22-HT-SLI	850-0074-22HT-SLI
	230C RFID Tag, 22mm dia., N213	HF-1572-22HT-N213	850-0074-22HT-N213
	230C RFID Tag, 30mm dia., MC1K	HF-1572-30HT-MC1K	850-0074-30HT-MC1K
	230C RFID Tag, 30mm dia. SLIS	HF-1572-30-HT-SLIS	850-0074-30HT-SLIS
	230C RFID Tag, 50mm dia. SLIS	HF-1572-50-HT-SLIS	850-0074-50HT-SLIS
	230C RFID Tag, 50mm dia. MC1K	HF-1572-50HT-MC1K	850-0074-50HT-MC1K



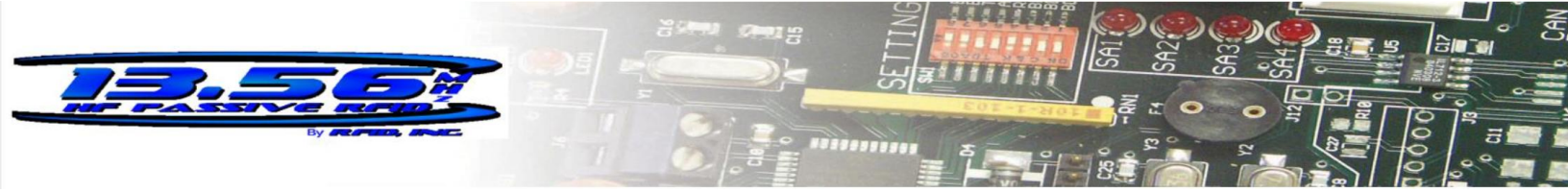

High Frequency 13.56 MHz Data Sheet

FPC Ario Style Tags

Model HF-1500 Series

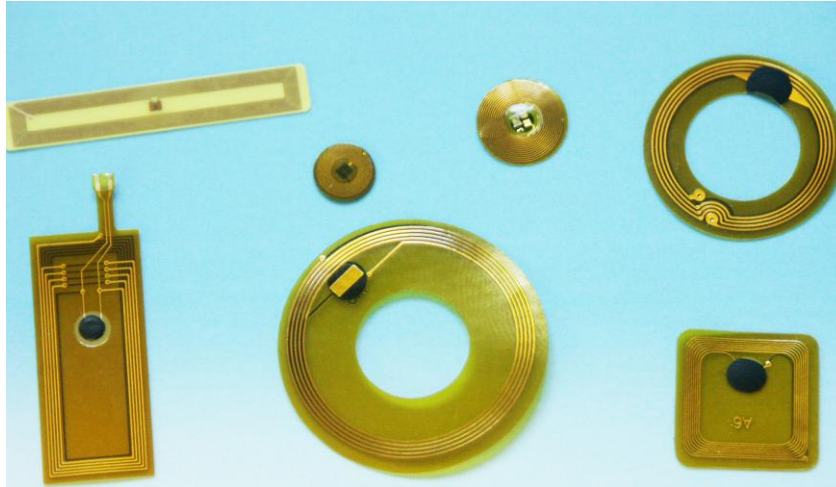

Specifications:	Dimensions:	7.6mm diameter x 1mm 9mm diameter x 1mm 5mm x 5mm x 1mm 14mm x 14mm x 1mm 25mm x 10mm x 1mm 30mm x 5mm x 1mm 19mm diameter OD x 11mm ID 26mm diameter OD x 10mm ID	Custom Sizes Available
	All Tags measure less than 1mm in height		
	Material:	Substrate: PET (Polyester Film) Antenna: Copper Etching	FPC Option Peel & Stick Backing
	Storage Temperature:	-40°F to 185°F	-40°C to +85°C
	Operating Temperature:	-40°F to +131°F	-40°C to +55°C
	Ingress Protection:	IP-67	

Part Numbering	Description	Model Number	Part Number
	FPC 5mm x 5mm Ario Tag, N213	HF-1500-0505-N213	850-0003-0505-N213
	PET 7.6mm diameter Ario Tag	HF-1500-7.6	850-0003-7.6
	PET 9mm diameter Ario 370-S Tag, SLI	HF-1500-9-SLI	850-0003-09-SLI
	FPC 10mm square Ario Tag, SLIX	HF-1500-1010-SLIX	850-0003-1010-SLIX
	FPC 10mm square Ario Tag, SLIX2	HF-1500-1010-SLIX2	850-0003-1010-SLIX2
	PET 14mm x 14mm Ario SM Style	HF-1500-1414	850-0003-1414
	PET 19mm dia w/11mm center	HF-1500-19	850-0003-19
	FPC 22mm x 4mm Ario Tag	HF-1500-2204-SLIX	850-0003-2204-SLIX
	PET 26mm dia. w/10mm center, SLIX	HF-1500-26-SLIX	850-0003-26-SLIX
	PET 25mm x 10mm Ario Tag	HF-1500-2510	850-0003-2510
	PET 30mm x 5mm Ario Tag, SLIX2	HF-1500-3005-SLIX2	850-0003-3005-SLIX2



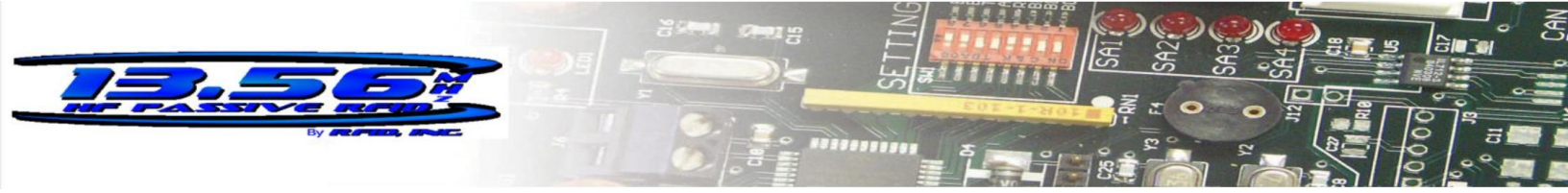

PCB/FR4 Tags

Model HF-1501 Series

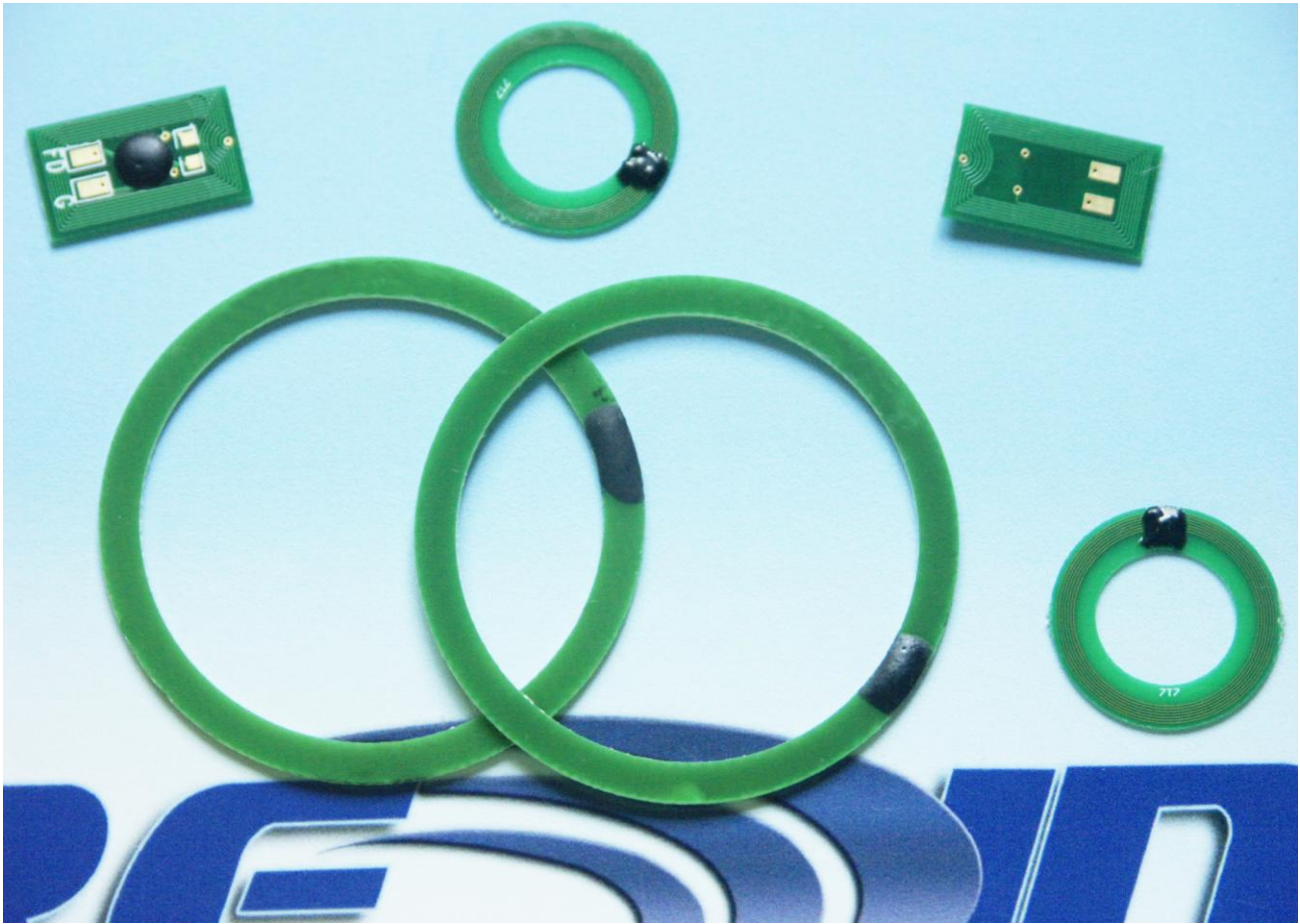

Specifications:	Dimensions:	16mm dia. OD x 10mm ID x 1mm 38mm dia. OD x 32mm ID x 1mm 20mm x 10mm x 1mm	Custom Sizes Available
	Material:	PCB FR4, etched coil	
	Storage Temperature:	-40°F to 185°F	-40°C to +85°C
	Operating Temperature:	-40°F to +131°F	-40°C to +55°C
	Ingress Protection:	IP-67	

Part Numbering	Description	Model Number	Part Number
	PCB/FR4 16mm Ring Tag	HF-1501-16	850-0001-16
	PCB/FR4 20mm RFID Ring Tag	HF-1501-20-N213	850-0001-20-N213
	PCB/FR4 38mm Ring Tag	HF-1501-38	850-0001-38
	PCB/FR4 20x10mm Tag	HF-1501-20x10	850-0001-2010
	PCB/FR4 30x10mm RFID Tag	HF-1501-3010-SLIX	850-0001-3010-SLIX



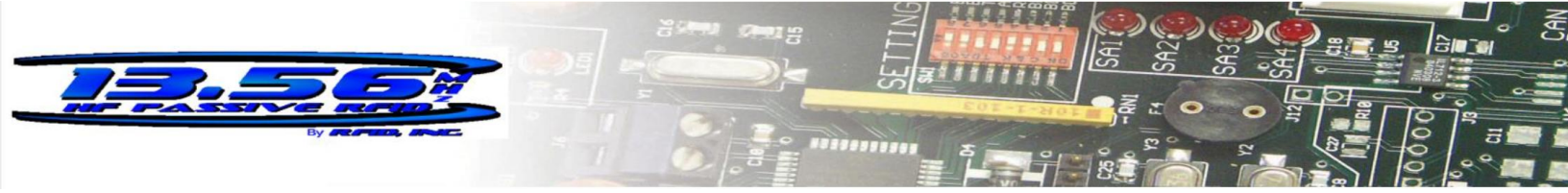

Air Coil & Clear Laminate Tags

Model HF-1502 Series



Specifications:	Dimensions:	3mm, 5mm, 9mm, 20mm 30mm, 44mm, 50mm diameter	Custom Sizes Available
	Material:	Copper Coil + PCB Module Laminate Film where applicable	Option Peel & Stick Backing
	Storage Temperature:	-40°F to 185°F	-40°C to +85°C
	Operating Temperature:	-40°F to +131°F	-40°C to +55°C
	Ingress Protection:	IP-67	

Part Numbering	Description	Model Number	Part Number
P/S = Peel & Stick	Air Coil 3mm diameter	HF-1502-03	850-0002-03
	Air Coil 5mm diameter	HF-1502-05	850-0002-05
	Air Coil 9mm diameter, SLI	HF-1502-09-SLI	850-0002-09-SLI
	PCB RFID Eye Tags, 9mm Diameter	HF-1760-09-SLI	850-0002-09-SLI
	Clear Laminate 20mm diameter	HF-1502-20	850-0002-20
	Clear Laminate 20mm P/S diameter, MC1K	HF-1502-20P/S-MC1K	850-0002-20P/S-MC1K
	Clear Laminate 20mm P/S diameter, F08	HF-1502-20P/S-F08	850-0002-20P/S-F08
	Clear Laminate P/S 25mm diameter, N213	HF-1502-25P/S-N213	850-0002-25P/S-N213
	Clear Laminate P/S 25mm diameter, SLIX	HF-1502-25P/S-SLIX	850-0002-25P/S-SLIX
	Clear Laminate 30mm diameter	HF-1502-30	850-0002-30
	Clear Laminate 30mm P/S diameter	HF-1502-30P/S	850-0002-30P/S
	Air Coil Tag, 36mm diameter	HF-1502-36-N213	850-0002-36-N213
	Air Coil Tag, 38mm diameter	HF-1502-38-SLIX	850-0002-38-SLIX
	Air Coil Tag, 44mm diameter	HF-1502-44	850-0002-44
	Air Coil Tag, 45mm diameter	HF-1502-45-SLIX	850-0002-45-SLIX
	Clear Laminate 50mm diameter	HF-1502-50	850-0002-50
	Clear Laminate 50mm P/S diameter	HF-1502-50P/S	850-0002-50P/S
	Clear Laminate P/S 51mm diameter	HF-1502-51P/S-N213	850-0002-51P/S-N213



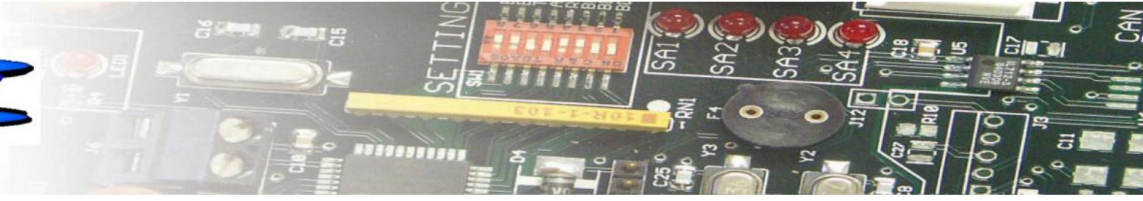

Inlays or Printable Thermal Transfer Labels

Model HF-1503 Series

Specifications:	Dimensions:	See Table Below	Custom Sizes Available
	Material:	PET (Polyester Film) Substrate Coated Paper	Thermal Transfer RFID Label with Acrylic Adhesive
	Storage Temperature:	-40°F to 185°F	-40°C to +85°C
	Operating Temperature:	-40°F to +131°F	-40°C to +55°C

Coil Size	Wet Inlay Size	Label Size	Photo (Deliverable on Rolls or Sheets)	Part Number Add -LB for Label Format
Circular				
12mm	14mm	16mm	<p>INLAY LABEL</p>	850-0103-12
18mm	20mm	22mm		850-0103-18
20mm	22mm	24mm		850-0103-20
22mm	24mm	26mm		850-0103-22
23mm	25mm	27mm		850-0103-23
24mm	26mm	28mm		850-0103-24
25mm	27mm	30mm		850-0103-25
36mm	38mm	40mm		850-0103-26
40mm	42mm	44mm		850-0103-40
111mm	113mm	115mm		850-0103-111
Square				
15mm sq.	17mm	19mm	<p>INLAY LABEL</p>	850-0103-15SQ
26mm sq.	28mm	30mm		850-0103-26SQ
45mm sq.	47mm	49mm		850-0103-45SQ
47mm sq.	49mm	51mm		850-0103-47SQ
50mm sq.	52mm	54mm		850-0103-50SQ
Rectangular				
17x9mm	19x11	21x13		850-0103-1911
18x8mm	20x10	22x12		850-0103-2010
20x15mm	22x17	24x19		850-0103-2015
32x15mm	34x17	36x19		850-0103-3215
38x23mm	40x25	42x27		850-0103-3823
40x25mm	42x27	44x29		850-0103-4025
50x30mm	52x32	54x34		850-0103-5030
50x40mm	52x42	54x44		850-0103-5040
52x15mm	54x17	56x19		850-0103-5215
76x45mm	78x47	80x49		850-0103-7645
86x54mm	88x56	90x58		850-0103-8654

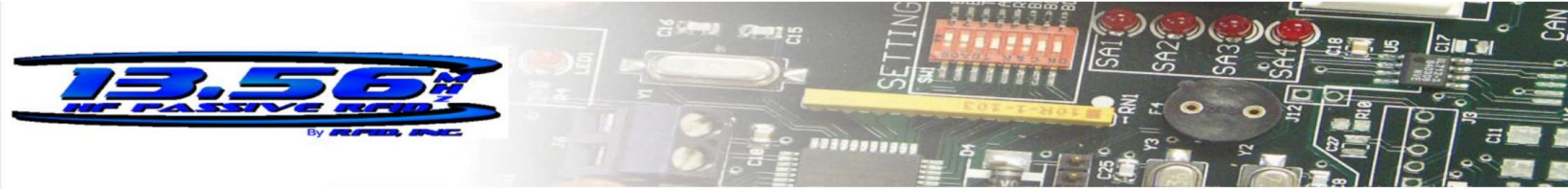

Metal Mount Label & PVC Tags

Model HF-1504 Series

NOTE: Most all Tags can be manufactured to be Metal Mount, please inquire.



Specifications:	Dimensions:	25mm diameter x 1mm 30mm square x 1mm 40mm x 25mm 65mm x 25mm (PVC)	Custom Sizes Available
	Material:	PET + Ferrous backing PVC Laminate + Ferrous backing	Peel & Stick Backing
	Storage Temperature:	-40°F to 185°F	-40°C to +85°C
	Operating Temperature:	-40°F to +131°F	-40°C to +55°C
	Ingress Protection:	IP-67	

Part Numbering	Description	Model Number	Part Number
	Metal Mount PET Label 25mm dia.	HF-1504-25-SLIX	850-0104-25-SLIX
	Metal Mount PET Label 30mm sq.	HF-1504-3030-SLIX	850-0104-3030-SLIX
	Metal Mount PET Label 40x25mm	HF-1504-4025-SLIX	850-0104-4025-SLIX
	Metal Mount PVC 65x25mm	HF-1504-6525	850-0104-6525
	Metal Mount PET Label 50x50mm	HF-1504-5050-SLIX	850-0104-5050-SLIX
	ABS RFID Metal Mountable Tag	HF-1562-7931-SLIX	850-0007-7931-SLIX
	Metal Mount PET Label 86x54mm	HF-1504-8654-SLIX	850-0104-8654-SLIX



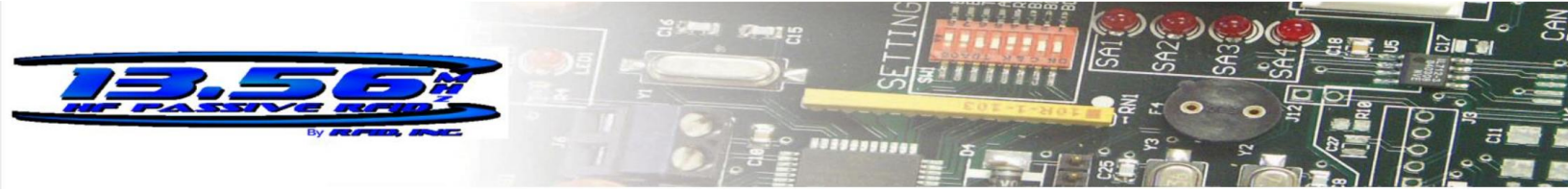

PVC Laminate & Fiberglass Disc Tags

Model HF-1561 Series

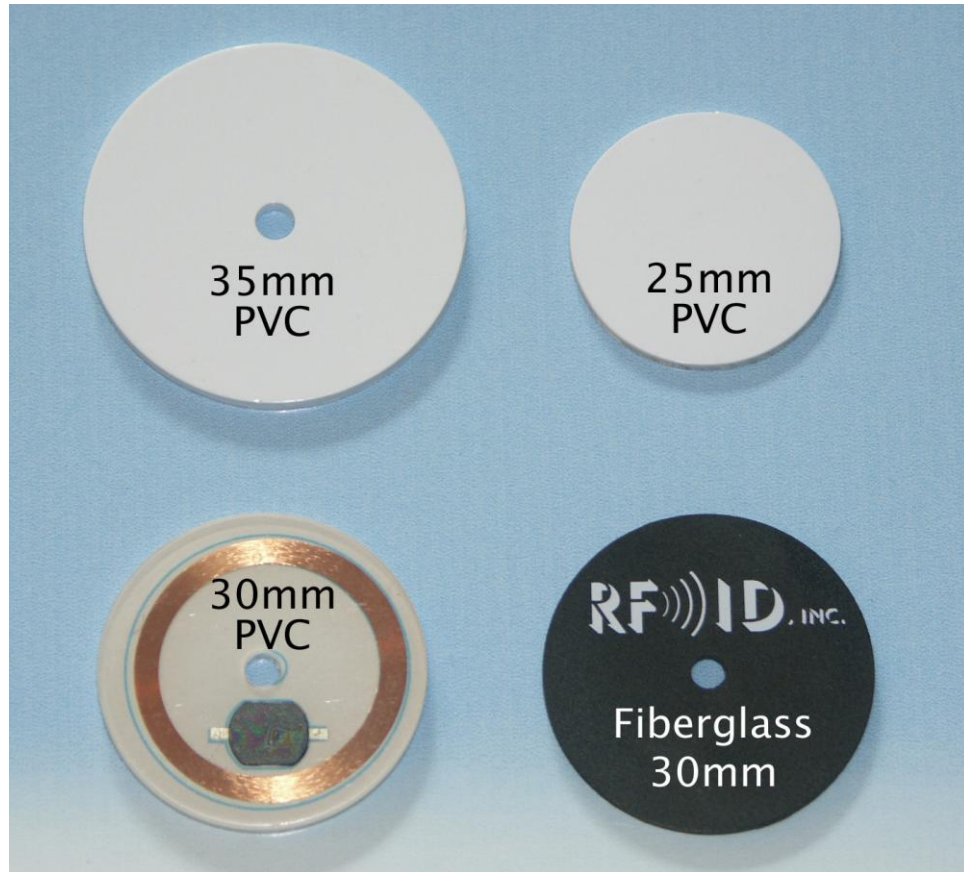

Specifications:	Dimensions:	25mm x 1mm 30mm x 2mm 35mm x 2mm 30mm x 1mm (Fiberglass)	Custom Sizes Available Option Peel & Stick Backing
	Material:	PVC Laminate (white)	Fiberglass (black)
	Storage Temperature:	-40°F to 185°F	-40°C to +85°C
	Operating Temperature:	-40°F to +131°F	-40°C to +55°C
	Ingress Protection:	IP-68	

Part Numbering	Description	Model Number	Part Number
P/S = Peel & Stick	PVC Laminate, 19mm P/S, S-SLIX	HF-1561-19P/S-SLIX	850-0006-19P/S-SLIX
	PVC Laminate, 25mm, F08	HF-1561-25-F08	850-0006-25-F08
	PVC Laminate, 25mm P/S	HF-1561-25-P/S	850-0006-25P/S
	Fiberglass, 30mm w/center hole	HF-1561-30-FG30	850-0006-30-FG30
	PVC Laminate, 30mm w/center hole	HF-1561-30	850-0006-30
	PVC Laminate, 30mm w/hole P/S	HF-1561-30-P/S	850-0006-30P/S
	PVC Laminate, 35mm w/center hole SLIX	HF-1561-35-SLIX	850-0006-35-SLIX
	PVC Laminate, 35mm w/hole P/S	HF-1561-35-P/S	850-0006-35P/S
	PVC Laminate Disc Tag 38mm, MC1K	HF-1561-38-MC1K	850-0006-38-MC1K
	PVC Laminate Disc Tag 38mm, SLIX2	HF-1561-38-SLIX2	850-0006-38-SLIX2



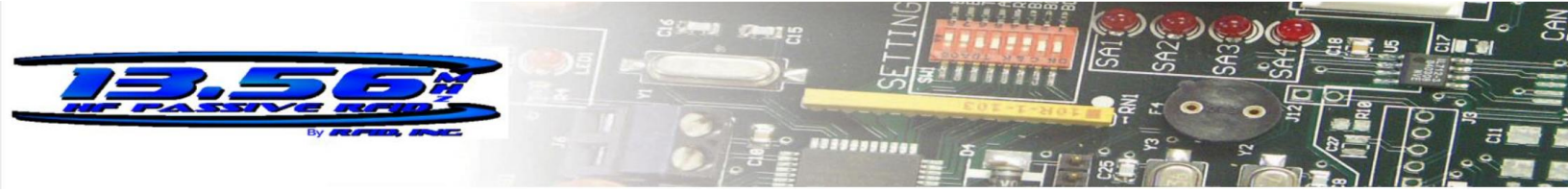

ABS & Polycarbonate Disc Tags

Model HF-1562 Series

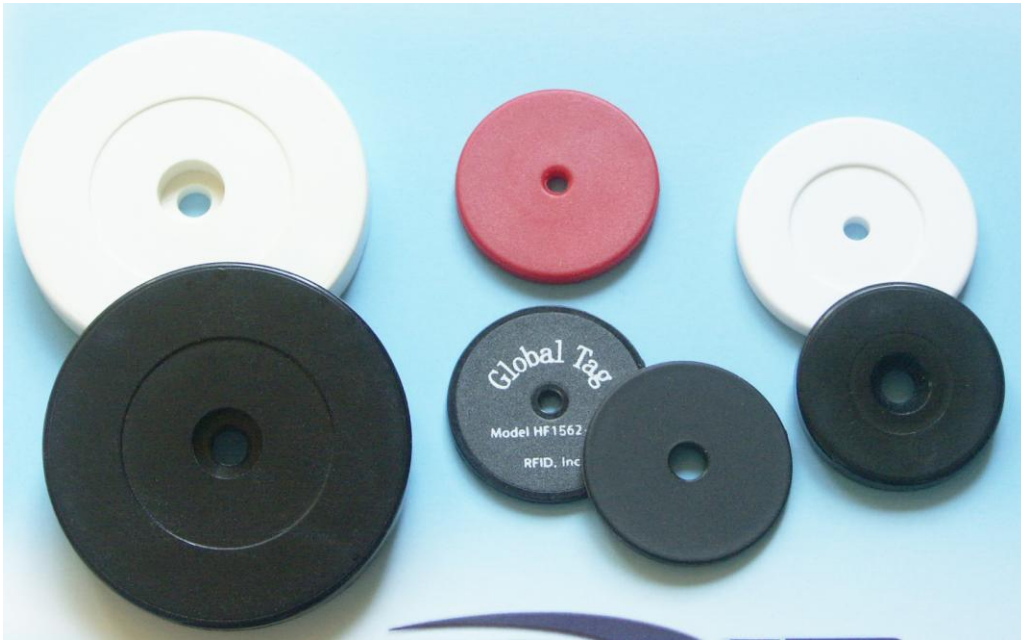

Specifications:	Dimensions:	20mm x 4mm 30mm x 2mm w/4mm hole 30mm x 2.5mm w/5mm hole 30mm x 5mm w/5mm hole 35mm x 4mm w/4mm hole 36mm x 4mm w/4mm hole 50mm x 8mm w/5mm hole	Custom Sizes Available
	Material:	ABS - Sonically Welded	Polycarbonate - Global Tag
	Storage Temperature:	-40°F to 185°F	-40°C to +85°C
	Operating Temperature:	-40°F to +131°F	-40°C to +55°C
	Ingress Protection:	IP-67	

Part Numbering	Description	Model Number	Part Number
	20mm x 4mm ABS Disc	HF-1562-20	850-0007-20
	25mm x 4.3mm, SLIX2	HF-1562-25-SLIX2	850-0007-25-SLIX2
	30mm Global Tag, Polycarbonate	HF-1562-30GL	850-0007-30GL
	30mm Global Tag, F08, ABS Disc	HF-1562-30GL-F08	850-0007-30GL-F08
	30mm Global Tag, SLIX, ABS Disc	HF-1562-30GL-SLIX	850-0007-30GL-SLIX
	30mm Global Tag, UL, ABS Disc	HF-1562-30GL-UL	850-0007-30GL-UL
	30mm ABS Disc, F08	HF-1562-30-F08	850-0007-30-F08
	30mm Polycarbonate, SLIX	HF-1562-30-SLIX	850-0007-30-SLIX
	30mm, ABS Disc, ICODE1	HF-1562-30-ICODE1	850-0007-30-ICODE1
	35mm, ABS Disc, SLI	HF-1562-35-SLI	850-0007-35-SLI
	35mm PA6 Disc Tag, SLIX2	HF-1562-35PA6-SLIX2	850-0007-35PA6-SLIX2
	35mm ABS Disc Tag, F08	HF-1562-35-F08	850-0007-35-F08
	79x31mm, ABS, SLIX	HF-1562-7931-SLIX	850-0007-7931-SLIX



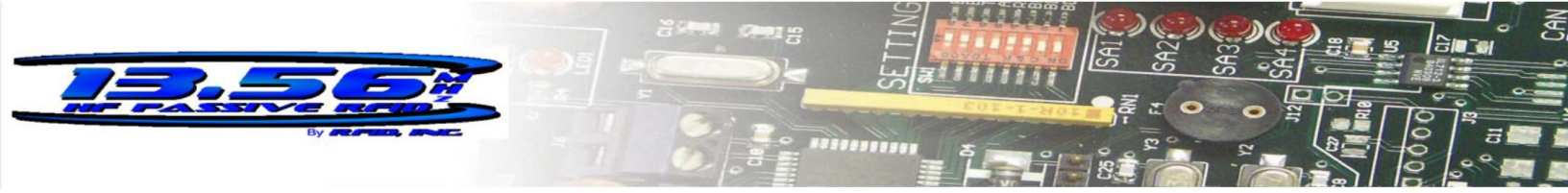

Keyfobs

Model HF-1568 Series



Specifications:	Material:	See Description Below	Customized graphics or logo when applicable
	Storage Temperature:	-40°F to 185°F	-40°C to +85°C
	Operating Temperature:	-40°F to +131°F	-40°C to +55°C
	Ingress Protection:	IP-65 to P-68	

Part Numbering	Description	Model Number	Part Number
	Fiberglass RFID Keyfob 45x30mm	HF-1568-01-BLK-SLI	850-0100-01-BLK-SLI
	Clear Epoxy Keyfob 40mm dia.	HF-1568-02-40	850-0100-02-40
	Clear Epoxy Keyfob, 40x26mm	HF-1568-02-4026	850-0100-02-4026
	Clear Epoxy Keyfob, 45x18mm	HF-1568-02-4518	850-0100-02-4518
	Clear Epoxy Keyfob, 45x28mm	HF-1568-02-4528	850-0100-02-4528
	Clear Epoxy Keyfob, 50x30mm	HF-1568-02-5030	850-0100-02-5030
	Clear Epoxy Keyfob, 55x28mm	HF-1568-02-5528	850-0100-02-5528
	Clear Epoxy Oval Keyfob, 58x30mm	HF-1568-02-5830	850-0100-02-5830
	Clear Epoxy Oval Keyfob, 61x28mm	HF-1568-02-6128	850-0100-02-6128
	Clear Epoxy Keyfob, 62x56mm	HF-1568-02-6256	850-0100-02-6256
	Clear Epoxy Keyfob, 68x18mm	HF-1568-02-6818	850-0100-02-6818
	Clear Epoxy Keyfob, 85x34mm	HF-1568-02-8534	850-0100-02-8534
	Clear Epoxy Keyfob, 120x80mm	HF-1568-02-12080	850-0100-02-12080
	Leather Keyfob, 15x68mm	HF-1568-04	850-0100-04
	Aquatic Keyfob, 15x68mm	HF-1568-05	850-0100-05
	Teardrop Keyfob, 15x68mm	HF-1568-06	850-0100-06
	Teardrop RFID Keyfob, Blue, 15x68mm	HF-1568-06-BLU-MC4K	850-0100-06-BLU-MC4K
	PVC Laminate Arch Keyfob, 15x68mm	HF-1568-08-SLIS	850-0100-08-SLIS
	Teardrop RFID Keyfob, Yellow, 15x68mm	HF-1568-06-Y-SLIX2	850-0100-06-Y-SLIX2
	Soft Silicon RFID Keyfob 68x25mm	HF-1568-09-SLIX2	850-0100-09-SLIX2



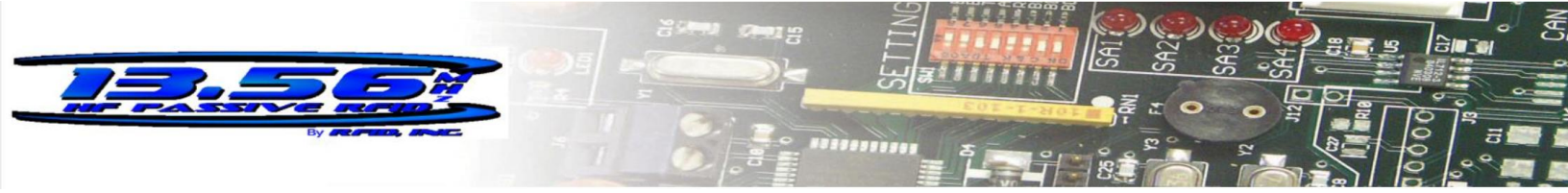

ISO Cards - Personnel Badges

Model HF-1570 Series



Photographed is ISO Card with Top Slot

Specifications:	Dimensions:	ISO Card - 86mm x 54mm	
	Material:	PVC, Laminate	Optional Printing
	Storage Temperature:	-40°F to 185°F	-40°C to +85°C
	Operating Temperature:	-40°F to +131°F	-40°C to +55°C
	Ingress Protection:	IP-67	

Part Numbering	Description	Model Number	Part Number
	ISO Card - No Slot, F08	HF-1570-NS-F08	850-0114-NS-F08
	ISO Card – No Slot, SLI	HF-1570-NSMG-SLI	800-0114-NSX
	ISO Card - Top Slot, SLI	HF-1570-TS-SLI	850-0114-TS-SLI
	ISO Card - Top Slot, N213	HF-1570-TS-N213	850-0114-TS-N213
	ISO Card - Top Slot, SLIX	HF-1570-TS-SLIX	850-0114-TS-SLIX
	ISO Card - Top Slot, F08	HF-1570-TS-F08	850-0114-TS-F08
	ISO Card – No Slot, MC1K	HF-1570-NSPET-MC1K	850-0114-NSPET-MC1K
	ISO Card – No Slot, PX2K	HF-1570-NSPET-PX2K	850-0114-NSPET-PX2K
	ISO Card – No Slot, NSNM-SLI	HF-1570-NSNM-SLI	850-0114-NSNM-SLI
	ISO Card – Side Slot	HF-1570-SS	850-0114-SS
	ISO Card - MS - RW	HF-1570-HID-NS	850-0114-HID-NS
	ISO Card - Top Slot - RO	HF-1570-HID-TS	850-0114-HID-TS
	ISO Card - Top Slot - RW	HF-1570-HID-SS	850-0114-HID-SS
	ISO Card – No Slot - SLI	HF-1570-NSMG-SLI	850-0114-NSMG-SLI



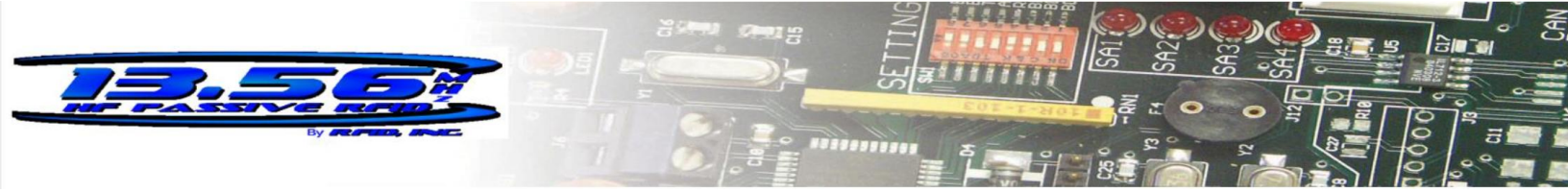

Wrist Band Tags

Model HF-1571 Series



Specifications:	Material:	Soft Silicon Rubber	ABS w/Velcro Strap
		PVC (disposable patient band)	ABS w/Watch Strap
	Storage Temperature:	-40°F to 185°F	-40°C to +85°C
	Operating Temperature:	-40°F to +131°F	-40°C to +55°C
	Ingress Protection:	IP-67	

Part Numbering	Description	Model Number	Part Number
	Wristband, Patient Style	HF-1571-PS	850-0110-PS
	Wristband, Slip Bead	HF-1571-SB-F08	50-0110-SB-F08
	Wristband, Slap On	HF-1571-SLAP-F08	850-0110-SLAP-F08
	Wristband, Silicon Slip On, F08	HF-1571-SS-F08	850-0110-SS-F08
	Wristband, Silicon w/Hasp, SLIX	HF-1571-SH-SLIX	850-0110-SH-SLIX
Add -Color to Part Number	Wristband, ABS w/Velcro, F08	HF-1571-ABS-VL-F08	850-0110-ABS-VL-F08
	Wristband, ABS, Nylon, Hasp, MC1K	HF-1571-ABS-NYL-MC1K	850-0110-ABS-NYL-MC1K



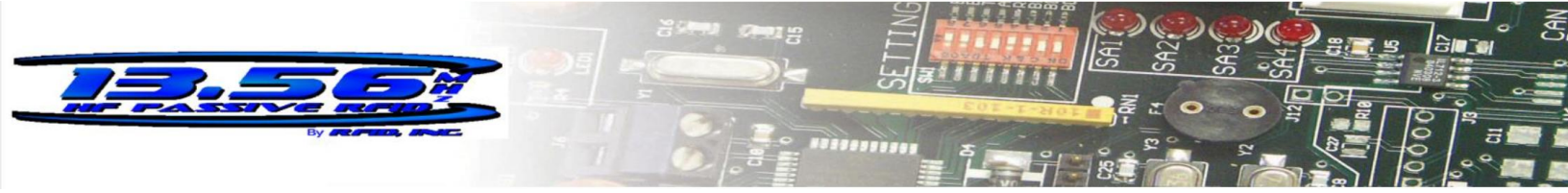

Glass Ampoule Tags

Model HF-1575 Series



Depicted is 3 x 13 mm

Environment:	Dimensions:	2x12mm, 3x13mm, 4x20mm, 3x34mm	Custom Sizes Available
	Material:	Glass	
	Storage Temperature:	-40°F to 185°F	-40°C to +85°C
	Operating Temperature:	-40°F to +131°F	-40°C to +55°C
	Ingress Protection:	IP-68	

Part Numbering	Description	Model Number	Part Number
	2x12mm Glass Ampoule, SLIX	HF-1575-212-SLIX	850-0073-212-SLIX
	2x12mm Glass Ampoule, N216	HF-1575-212-N216	850-0073-212-N216
	3x12mm Glass Ampoule, SLI	HF-1575-312-SLI	850-0073-312-SLI
	3x12mm Glass Ampoule, EM4233	HF-1575-312-EM4233	850-0073-312-EM4233
	3x13mm Glass Ampoule, SLIX	HF-1575-313-SLIX	850-0073-313-SLIX
	3x13mm Glass Ampoule, F08	HF-1575-313-F08	850-0073-313-F08
	4x20mm Glass Ampoule, F08	HF-1575-420-F08	850-0073-420-F08
	4x20mm Glass Ampoule, SLIX	HF-1575-420-SLIX	850-0073-420-SLIX
	3x34mm Glass Ampoule, SLIX	HF-1575-334-SLIX	850-0073-334-SLIX



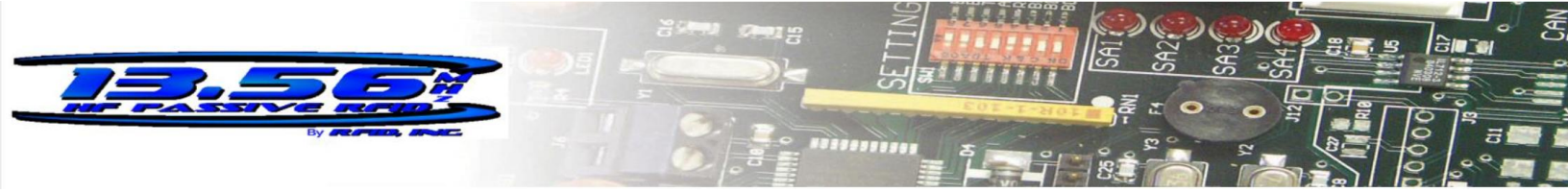

Small Diameter, Unique, & Laundry Tags

Model 1579 Series

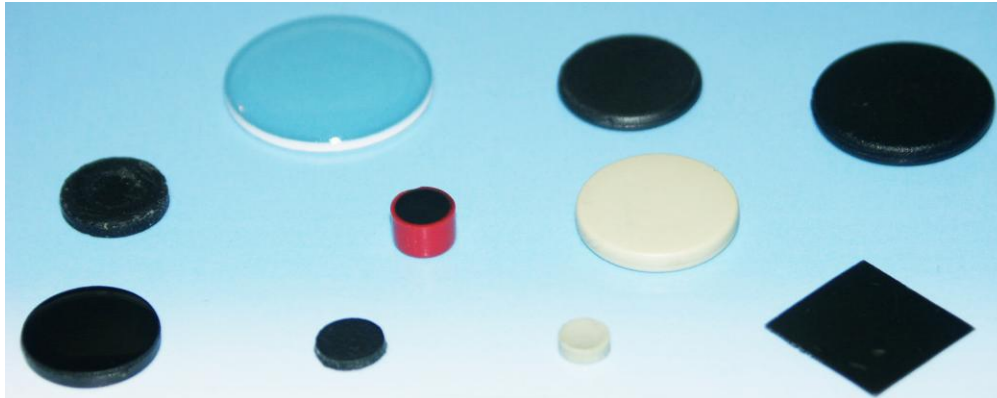

Specifications:	Laundry Tag - Dimensions:	9, 10, 11, 12, 13, 14, 15, 16, 17, 18 20, 22, 24, 26, 28mm dia. x 2mm	PPS + Epoxy
	Storage Temperature:	-40°F to +248°F indefinite -40°C to +320°F 30 min-200x -40°C to +392°F 30 sec-200x	-40°C to +120°C indefinite -40°C to +160°C 30 min-200x -40°C to +200°C 30 sec-200x
	Operating Temperature:	-40°F to +185°F	-40°C to +85°C
	Ingress Protection:	IP-68	
	Water Pressure:	300 Bars - 5 minutes	45 Bars - 10 hours
	Compression Strength:	Axial 1000 N - 10 seconds	Radial 1000 N - 10 seconds
	Pill Tags	5mm & 13mm diameter x 2mm	PPS + Epoxy, IP-68
	Orange Tea Cup Tag	6mm tall x 4mm diameter	PBT with Epoxy, IP-68
Soft Epoxy Tags	6mm & 10mm diameter x 2mm	Pliable Epoxy, IP65	
Potted Dome Tag, Light Blue	20mm x 2mm	Potted Epoxy, IP-68	
Square Epoxy Tag	13mm x 1mm	Rigid Potted Epoxy, IP-68	

Part Numbering	Description	Model Number	Part Number
	Laundry Tag, xx = diameter	HF-1579-LDxx	850-0113-LDxx
	Laundry Tag 9mm dia.	HF-1579-LD09-MC1K	850-0113-LD09-MC1K
	Laundry Tag 13mm dia.	HF-1579-LD13-SLI	850-0113-LD13-SLI
	Laundry Tag 14mm dia.	HF-1579-LD14-MC1K	850-0113-LD14-MC1K
	Laundry Tag 14mm dia.	HF-1579-LD14-TB04K	850-0113-LD14-TB04K
	Laundry Tag 16mm dia.	HF-1579-LD16-MC1K	850-0113-LD16-MC1K
	Laundry Tag 20mm dia.	HF-1579-LD20-SLIX	850-0113-LD20-SLIX
	Laundry Tag 28mm dia.	HF-1579-LD28-MC1K	850-0113-LD28-MC1K
	Hard Epoxy Tag 10x2mm	HF-1580-HE10-F08	850-0113-HE10-F08
	Pill Tag, 5mm	HF-1579-PL05-N216	850-0113-PL05-N216
	Pill Tag, 13x2mm	HF-1579-PL07-N213	850-0113-PL07-N213
	Pill Tag, 13mm	HF-1579-PL13	850-0113-PL13
	Orange Tea Cup Tag	HF-1579-TC	850-0113-TC
	Soft Epoxy Tag, 6mm	HF-1579-SE06	850-0113-SE06
	Soft Epoxy, 10mm	HF-1579-SE10	850-0113-SE10
	Potted Dome, Light Blue, 20mm	HF-1579-PD20-LB	850-0113-PD20-LB
	Square Epoxy, 13mm	HF-1579-SQE13	850-0113-SQE13



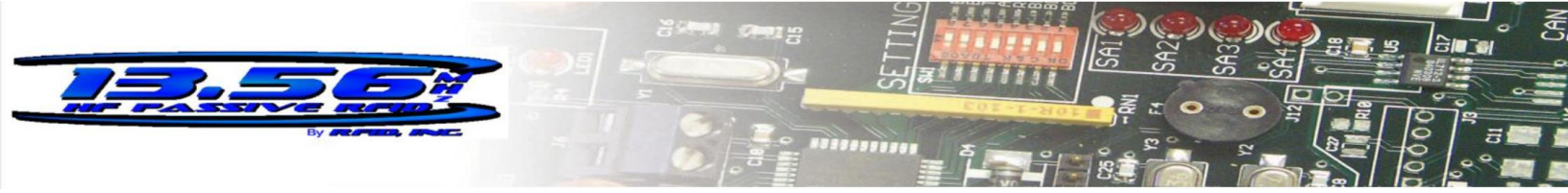

Custom & Subsurface Metal Mountable Tags

Model HF-1579 & 1580 Series

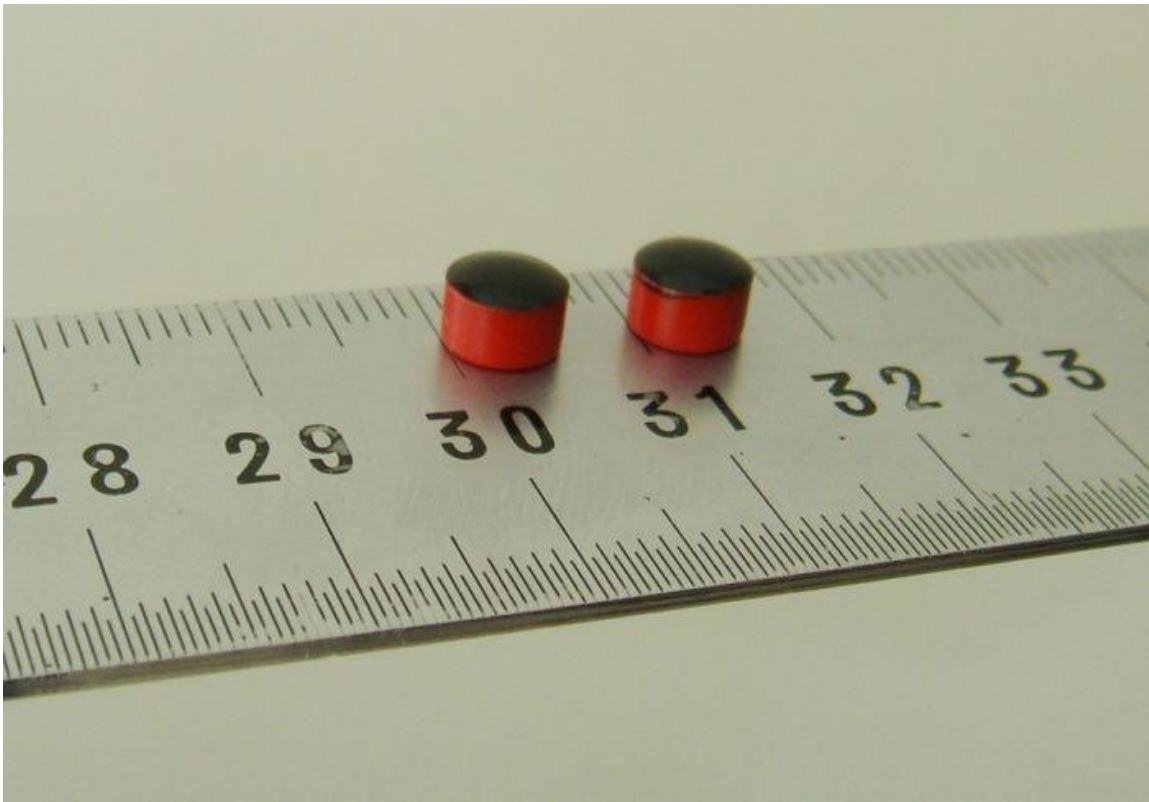

Environment:	Dimensions:	7.9x4.9mm, 6x4mm, 12x5.8mm, 10x4mm, 10x2.6mm	Custom Sizes Available
	Material:	ABS, Epoxy	
	Storage Temperature:	-40°F to +185°F	-40°C to +85°C
	Operating Temperature:	-40°F to +185°F	-40°C to +85°C
	Ingress Protection:	IP68	

Part Numbering	Description	Model Number	Part Number
	ABS Plug Tag, SLIX	HF-1579-A85M-SLIX	850-0210-A85M-SLIX
	Orange Tea Cup, SLIX	HF-1579-TC0604-SLIX	850-0210-0604-SLIX
	Donut Tag, SLIX	HF-1579-DT12-SLIX	850-0113-DT12-SLIX
	Clear Epoxy Disc Tag, SLIX	HF-1580-CE10-SLIX	850-0113-CE10-SLIX
	Hard Epoxy Tag, MC1K	HF-1580-HE10-MC1K	850-0113-HE10-MC1K
	Hard Epoxy Tag, SLIX	HF-1580-HE10-SLIX	850-0113-HE10-SLIX



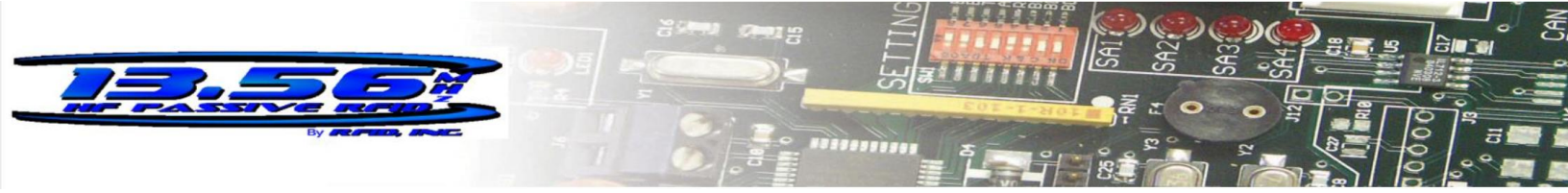

RFID Epoxy Tags Model HF-1580 Series



Environment:	Dimensions:	6x2mm, 10x2mm, 20x2mm, 13x1mm	Custom Sizes Available
	Material:	Epoxy	
	Storage Temperature:	-40°F to +185°F	-40°C to +85°C
	Operating Temperature:	-40°F to +185°F	-40°C to +85°C
	Ingress Protection:	IP68	

Part Numbering	Description	Model Number	Part Number
	Soft Epoxy Tag	HF-1580-SE06	850-0113-SE06
	Soft Epoxy Tag	HF-1580-SE10	850-0113-SE10
	Potted Dome Tag	HF-1580-PD20-LB	850-0113-PD20-LB
	Square Epoxy Tag	HF-1580-SQE13	850-0113-SQE13



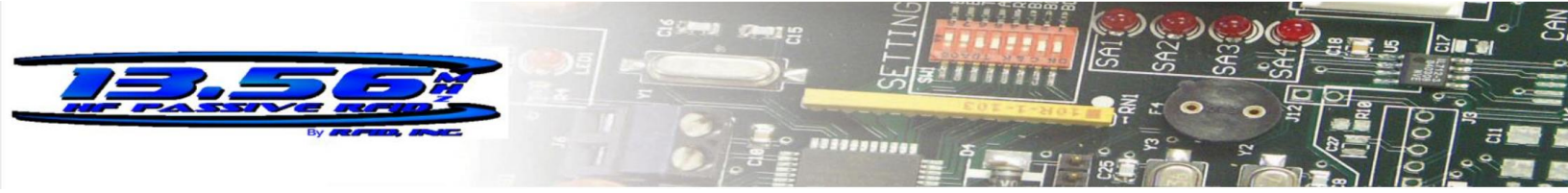

RFID Lipstick Tag Model HF-1787 Series



Environment:	Dimensions:	2.3"x.75"	
	Material:	Polycarbonate	2 Part Potting Compound
	Storage Temperature:	-40°F to +185°F	-40°C to +85°C
	Operating Temperature:	-40°F to +185°F	-40°C to +85°C
	Ingress Protection:	IP-68	

Part Numbering	Description	Model Number	Part Number
	In Floor Mounting Tag	HF-1787-SLIX	850-0017-00-SLIX

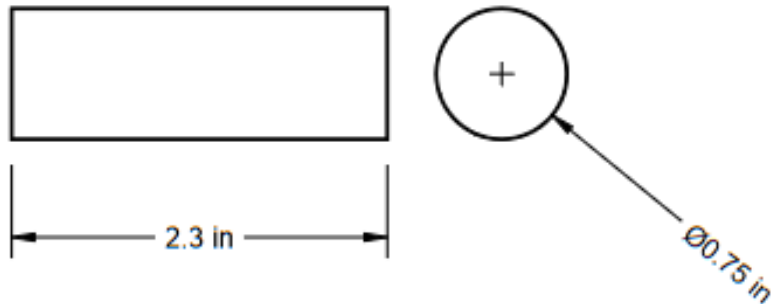

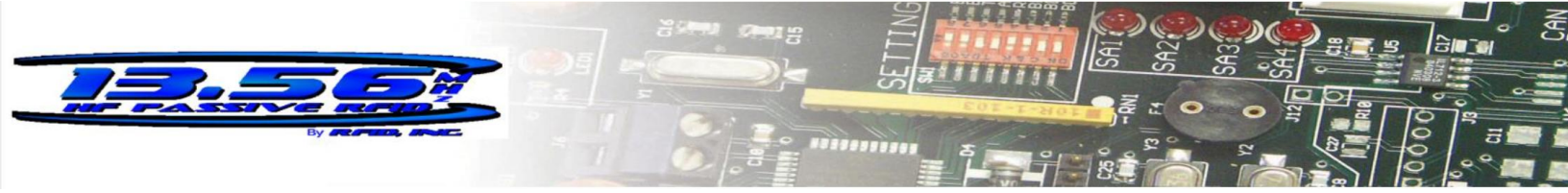

Client List (Partial)

USA Medical & Pharmacies:

Abbot Labs
 AmeriPharm
 Amphenol
 Anthem
 Bayer
 Baxter Healthcare
 Boston Scientific
 Cardinal Health
 CASI
 CDS/Procure
 Cigna Tel-Drug
 CR Bard
 CVS
 Eckerd Drug
 Edward's Life Science
 ExcelleRx
 FamilyMeds.com
 Humana
 Intuitive Surgical
 Kaiser Permanente
 McKesson SI/Baker
 Medtronic
 Optum Rx
 PacifiCare
 Parata
 Prescription Solutions
 Providence Health Care
 Rite Aid
 Rx Direct
 Smith's Medical
 Synergy Medical
 TCGRx
 Tel-Drug
 Veteran's Admin
 Walgreens
 Walmart
 WellPoint
 Wyeth Labs

USA Automotive:

Allen Bradley
 ATS
 Bendix
 BMW
 Caterpillar
 Cummins Engines
 Daimler AG
 Decoma
 Delphi
 Detroit Diesel
 Federal Mogul
 Fiat Chrysler
 Ford Motor Company
 General Motors
 Hirotec
 Honda
 Howmet
 John Deere
 Meridian Automotive

Michelin
 Neaton Automotive
 Polaris Industries
 Tesla
 Toyota
 Trident Automotive
 Visteon
 Volvo

Factory Floor:

Ace Hardware
 Alcoa
 Amana
 AT&T
 Avtron
 BAE Automation
 BASF
 Boeing Corporation
 BorgWarner
 BW Rogers
 Cargill
 Carlton-Bates
 CEI Automation
 Charbroil
 Conagra
 Copeland
 Cutler-Hammer
 Eastman Kodak
 Edgewater Automation
 EI DuPont
 Electrolux
 Eskay
 Esselte
 Estee Lauder
 Exxon Mobile
 FlexLink Conveyors
 Frigidaire
 GE Aviation
 General Electric
 Hagemeyer
 Hyster Yates
 Ingersoll Rand
 Inland Steel
 Kim Automation
 Knapp Automation
 Krauss-Maffei
 Lear Jets
 Marshall's
 Maytag
 Mitsubishi
 Motorola
 Nestle
 Nippon Steel
 OshKosh B'Gosh
 Osram Sylvania
 Pepsi (Quaker)
 POM Wonderful
 Proctor & Gamble
 Reliance Rockwell
 Rockwell
 Schick Razors

SCI Sanmina
 Sears
 SI/Handling Systems
 Square D Company
 Siemens
 Stanley Tools
 Swisslog
 Texas Instruments
 Tempurpedic
 TJ Maxx
 Trane
 TRW
 U.S. Steel
 Valeo Sylvania
 WEPCO
 Whirlpool
 Wunderlich-Malec

USA Routing/ASRS:

AGV Products
 Amerden
 Anheuser-Busch
 Bastian Solutions
 Fisher Dynamics
 Jervis Webb
 JBT
 Lemans
 Los Angeles Times
 Prilgrim's Pride
 The Denver Post
 The Boston Globe
 Transbotics
 Toyota AGV
 U.S. Air Force

USA Entertainment

Customer Loyalty:
 Bronx Zoo
 CBS Television
 Caesar's High Roller
 Ferris Wheel
 Electrosonic
 Hard Rock Café
 Heywood Engineering
 Maltbie
 NASCAR Hall of Fame
 Six Flags
 Smithsonian Museum
 Solomon Group
 Strategic Systems
 Technomedia
 Vail Resorts
 Walt Disney World
 WWII Museum

USA Other:

Atmel/Temic
 EFI Vutek
 H.E. Butt Grocery
 Hewlett Packard
 Honeywell

Los Alamos Labs
 Magic Chef
 NASA
 Nokia
 NY City MTA
 Publix
 Sandia National Labs
 Timken
 Tyco
 U.S. Navy
 Unilever
 UPS

AVI Scale Operations:

American Scale
 Apple Valley Scale
 Avery Weigh-Tronix
 Carlton Scale
 Halliburton
 Industrial Scale Systems
 Meldrum Scale
 Pacific Industrial Scale
 Rice Lake Weighing
 Sanstrom Scale
 Scales NW
 Soulder Scale
 Standard Scale
 Wingfield Scale

Asia:

Beijing Controlway (dist, China)
 Toyota (Japan)

Australia/Africa:

Alcoa World Alumina
 BHP Billiton Iron Ore
 Byrnescut Mining
 CMA Systems
 Dampier Salt
 Fortescue Metals
 Hamersley Iron
 Logitech Consultants
 Newcrest Telfer Gold Mine
 Pacific Automation (dist, AUS)
 Port Waratah
 Queens Creek
 Rio Tinto
 Robe River Iron
 Sinclair Knight Merz
 ThyssenKrupp
 Tomago Aluminum
 Voest-Alpine

Canada:

AG Simpson Automotive
 AMT Mach Tools (dist, Tor)
 ArcelorMittal
 Aurora Bar Code
 City of Fort St. John
 CraneSmart
 Dofasco

Kellogg's Cereal
 Keilhauer
 LSZ PaperTech
 Rotalec (distributor)
 Stelco Steel

Central & South America:

Fenwal (Dominican Rep.)
 General Electric (Mexico)
 Hylsa (Mexico)
 Logiseed (Dist Argentina)
 MABE Leiser (Mexico)
 SCI Sanmina (Mexico)
 Retex (Peru)
 RSI (Mexico)
 TecWise (distributor, Brazil)
 TRW (Mexico)

Europe:

BMW (UK)
 FQ (distributor, Spain)
 London Heathrow Airport (Baggage)
 Moncks & Crane (UK)
 ProvelT (distributor, UK)
 SCI Sanmina (Hungary)
 Securitas (Sweden)
 Tempore (Austria)
 TRW (UK & Germany)

USA Distributors:

Applied Automation (NY)
 Applied Controls (PA, MD, DE)
 Automation, Inc. (MN, ND, SD, IA, WI)
 Buckeye Controls (OH)
 Burns Controls (TX)
 C&E Sales (IN, OH, KY)
 CodeSource (TX)
 Cornerstone (TN, AL, GA, NC, SC, MS)
 Gibson Eng. (MA, CT, ME, RI)
 HH Barnun (MI, IN, OH, KY, NC, SC)
 Horizon (MI, IL, OH, FL)
 Industrial Controls (west MI)
 Innovative Control Inc. (IL)
 Lakeland Engineering (MN, WI, IA, ND, SD, MO, KS, NE)
 Midwest Engineering (Ohio)
 MSI Tech (CO, UT, AZ, NV, NM, CA, ID)
 Pacific Technical (SoCal)
 Power Motion (MO, KS, AK, OK, LA)
 Power/mation (MN, IA, WI, IL)
 Precise Motion (FL)
 PRI (NY, NJ)
 RR Floody (IL, IA)
 Taylor Data (SC, NC, FL)
 Valin Corporation (CA, AZ, UT, NV, WA, OR, ID)

